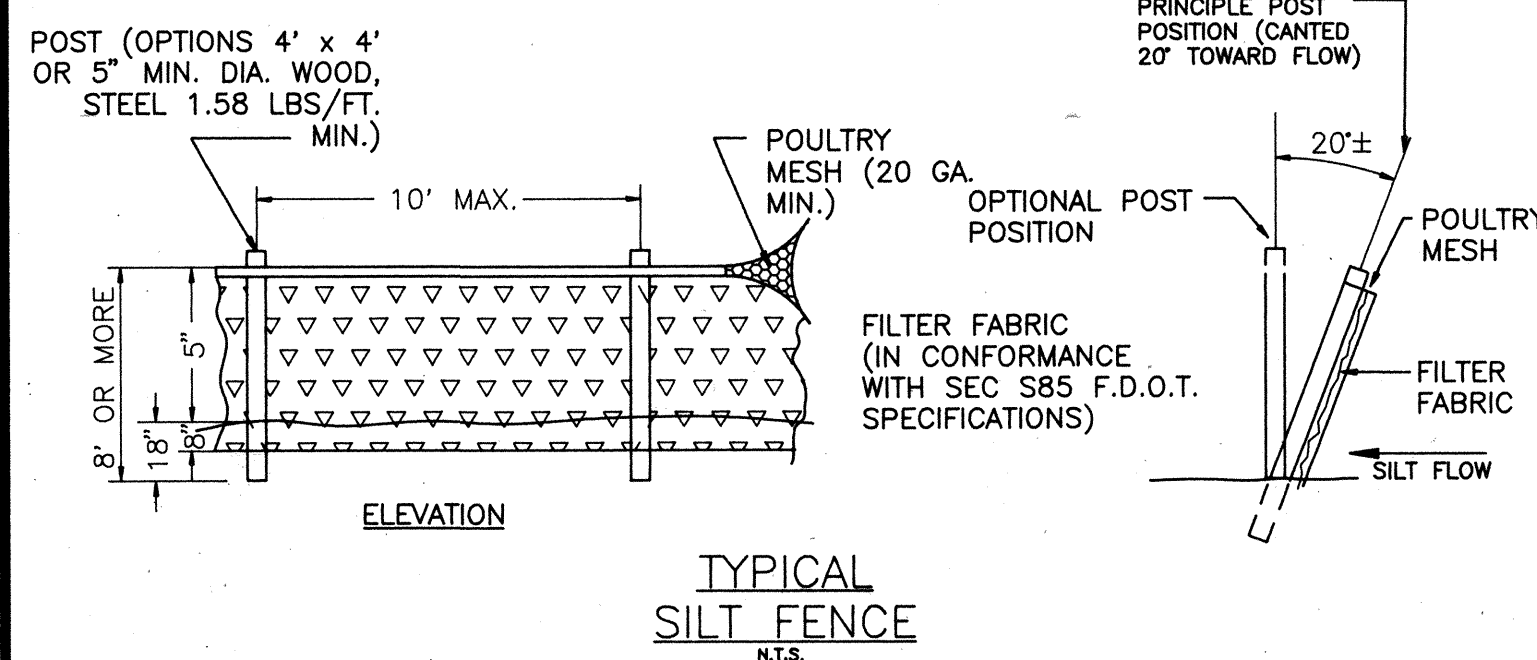

FIGURE 1



TYPICAL SILT FENCE
N.T.S.

FIGURE 2

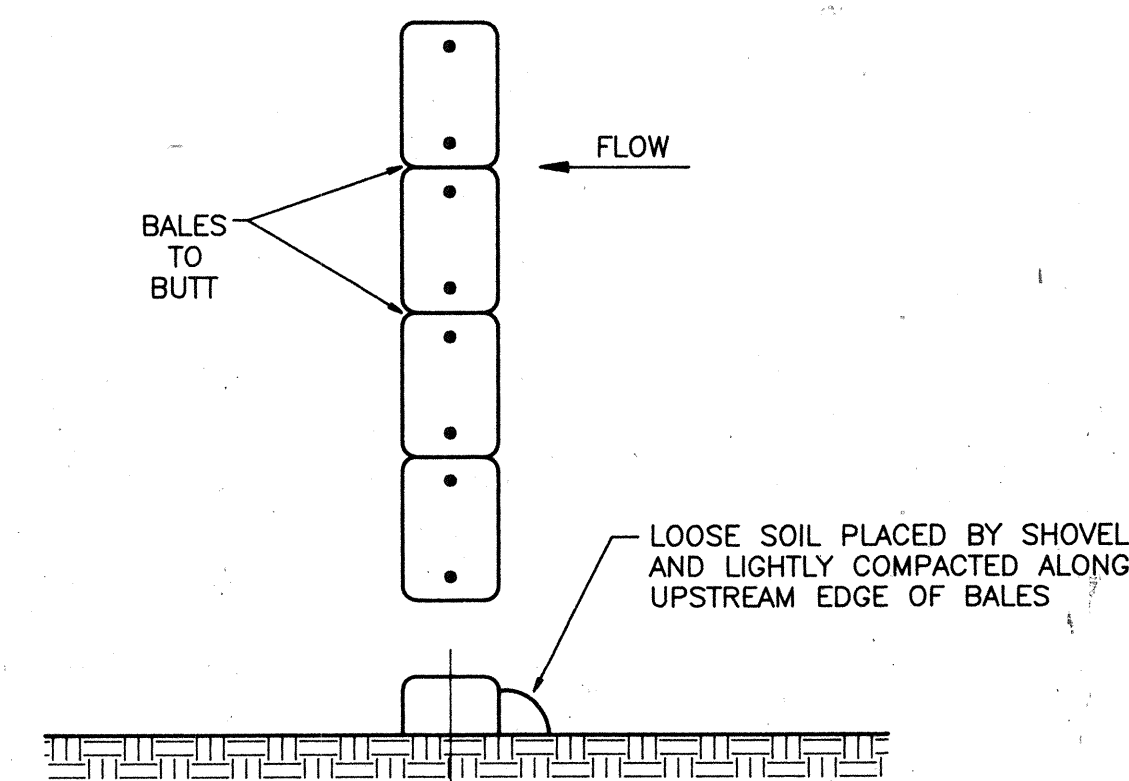
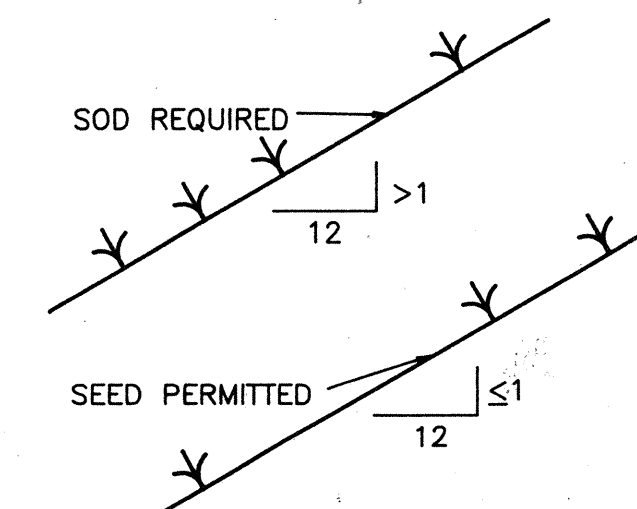
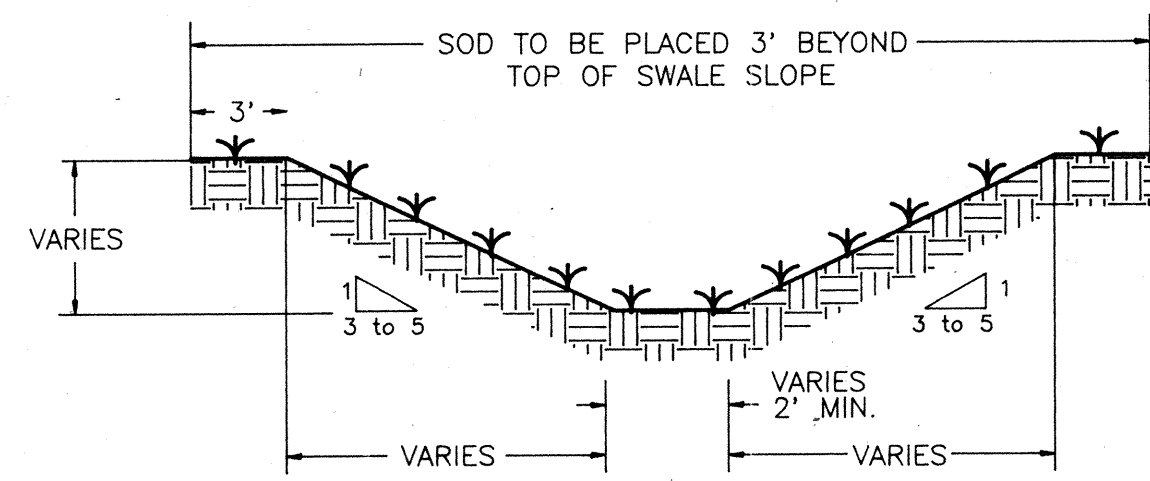

FIGURE 3



GRASS SLOPES
N.T.S.

FIGURE 4



TYPICAL SWALE SECTION
N.T.S.

FIGURE 5

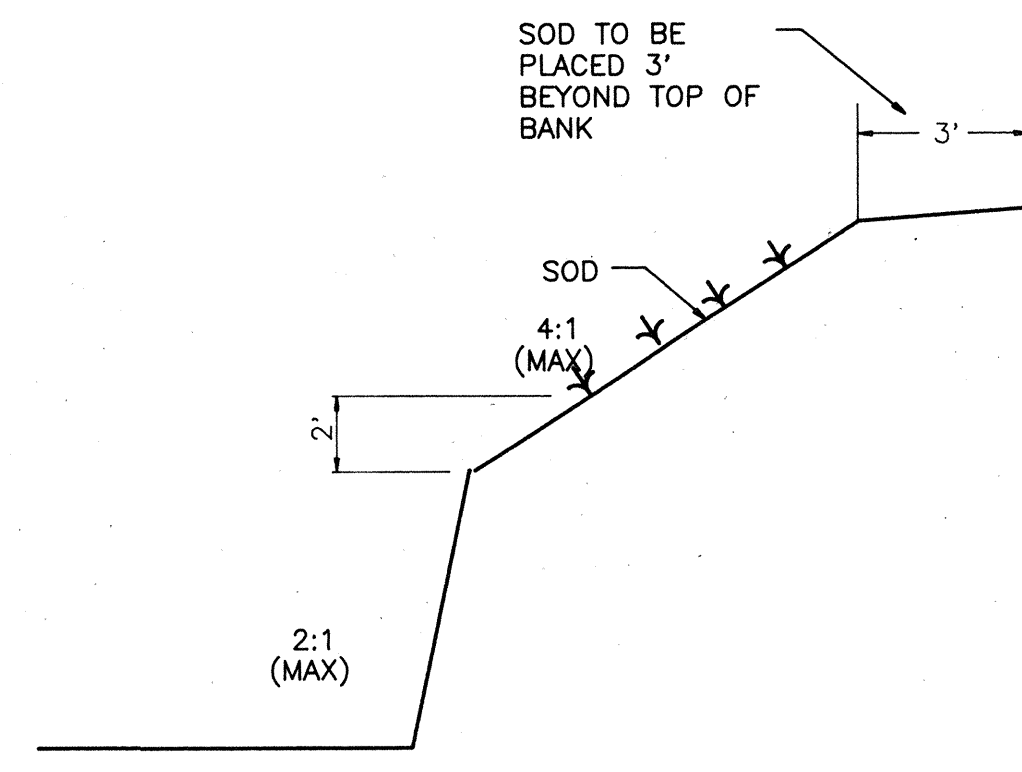

TYPICAL RETENTION/DETENTION
POND SECTION
N.T.S.

FIGURE 6

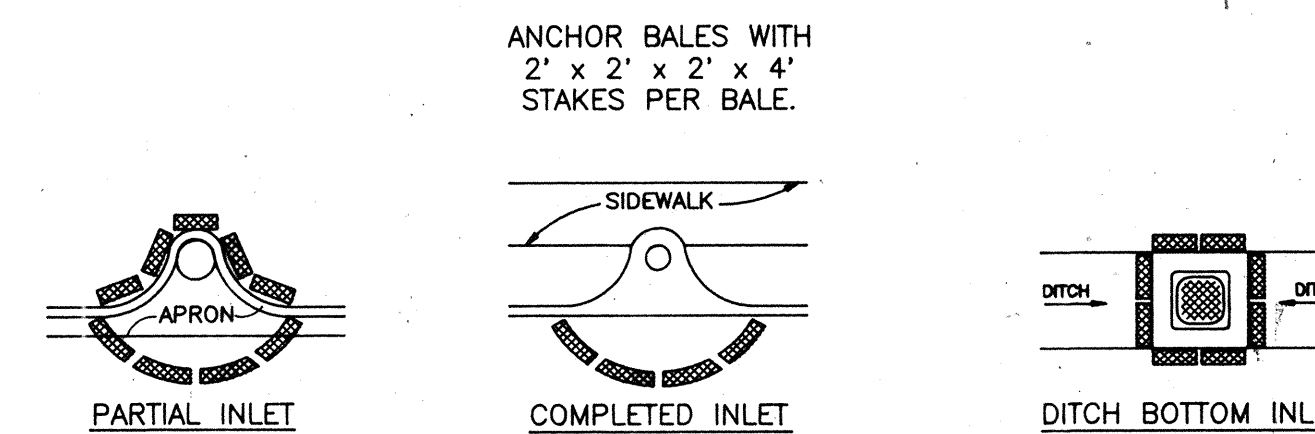

PROTECTION AROUND INLETS OR SIMILAR STRUCTURES
N.T.S.

FIGURE 7

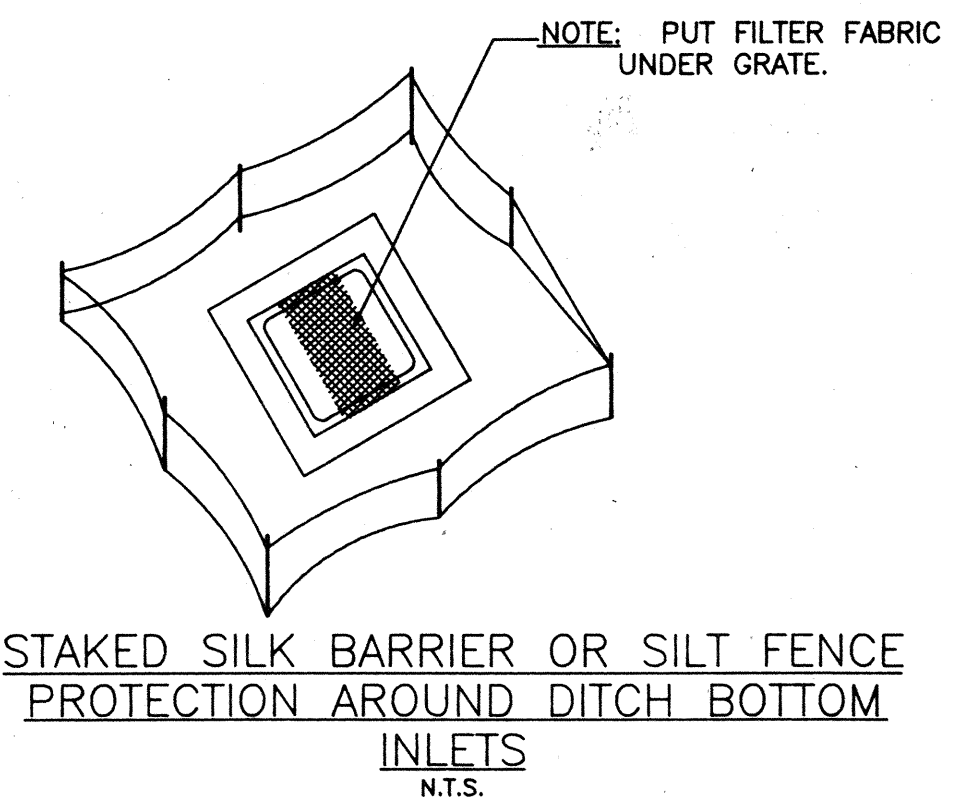

STAKED SILK BARRIER OR SILT FENCE
PROTECTION AROUND DITCH BOTTOM
INLETS
N.T.S.

FIGURE 8

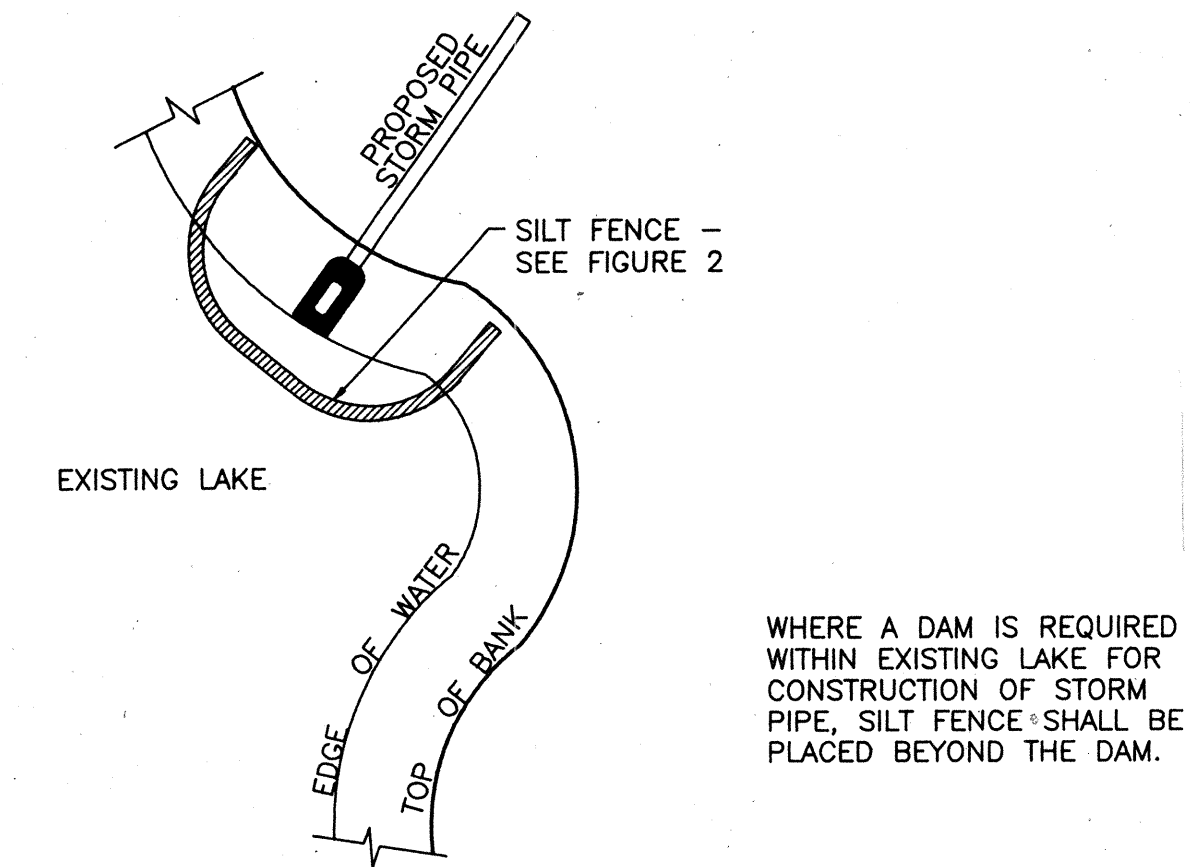

SILT BARRIER AT CONNECTION OF
STORM PIPE TO EXISTING LAKE
N.T.S.

FIGURE 9

WHERE A DAM IS REQUIRED WITHIN EXISTING LAKE FOR CONSTRUCTION OF STORM PIPE, SILT FENCE SHALL BE PLACED BEYOND THE DAM.

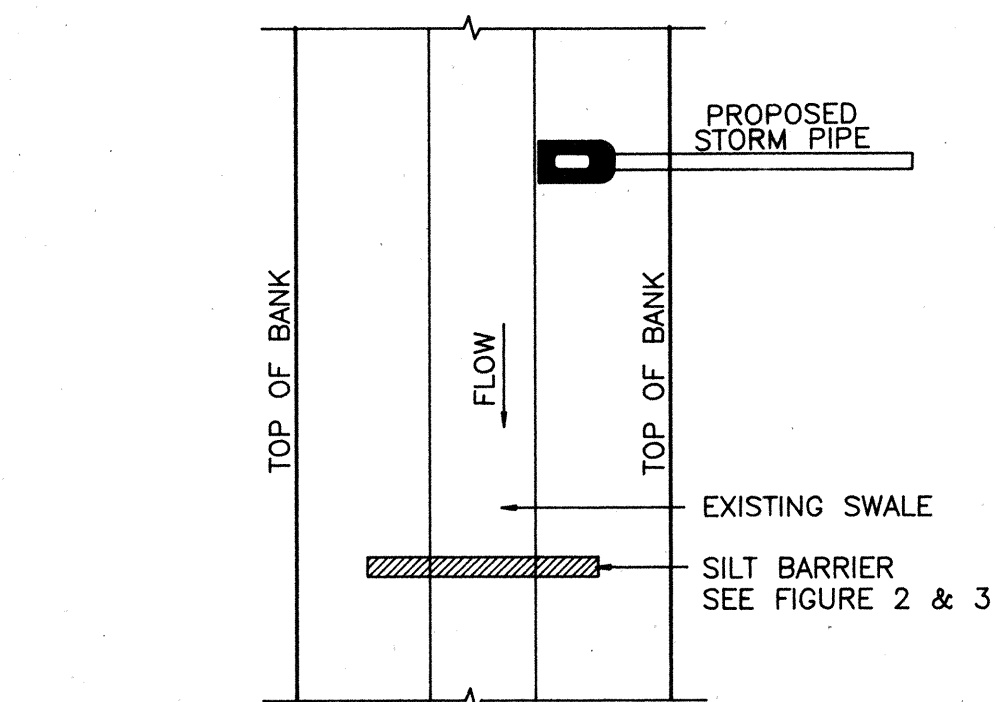

SILT BARRIER AT CONNECTION OF
STORM PIPE TO EXISTING SWALE
N.T.S.

FIGURE 10

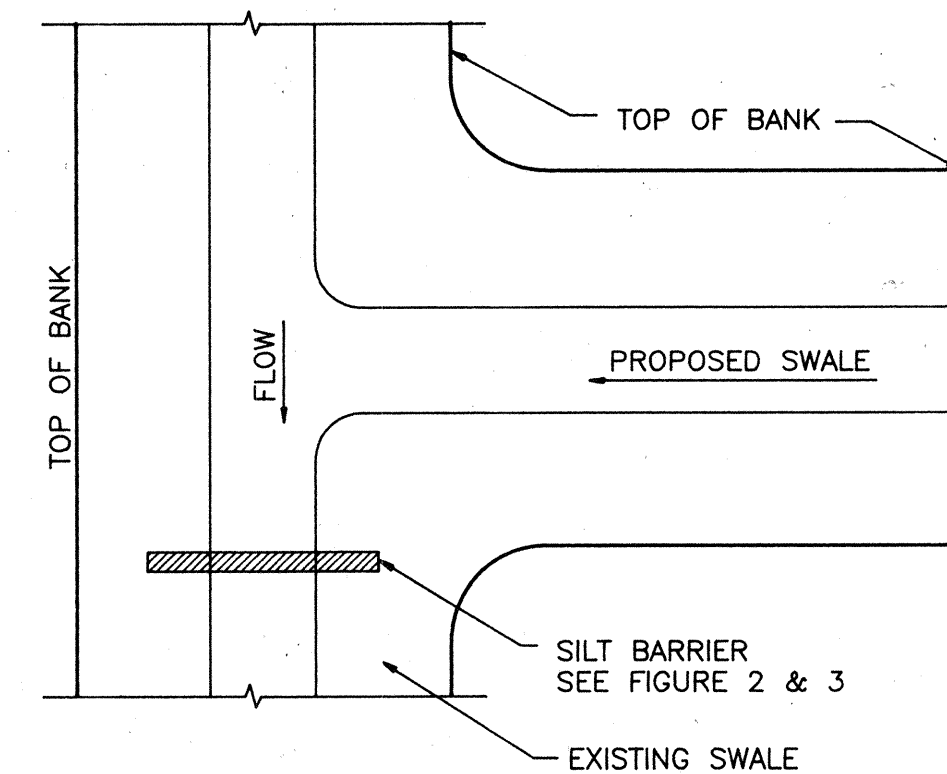

SILT BARRIER AT CONNECTION OF
SWALE TO EXISTING SWALE
N.T.S.

FIGURE 11

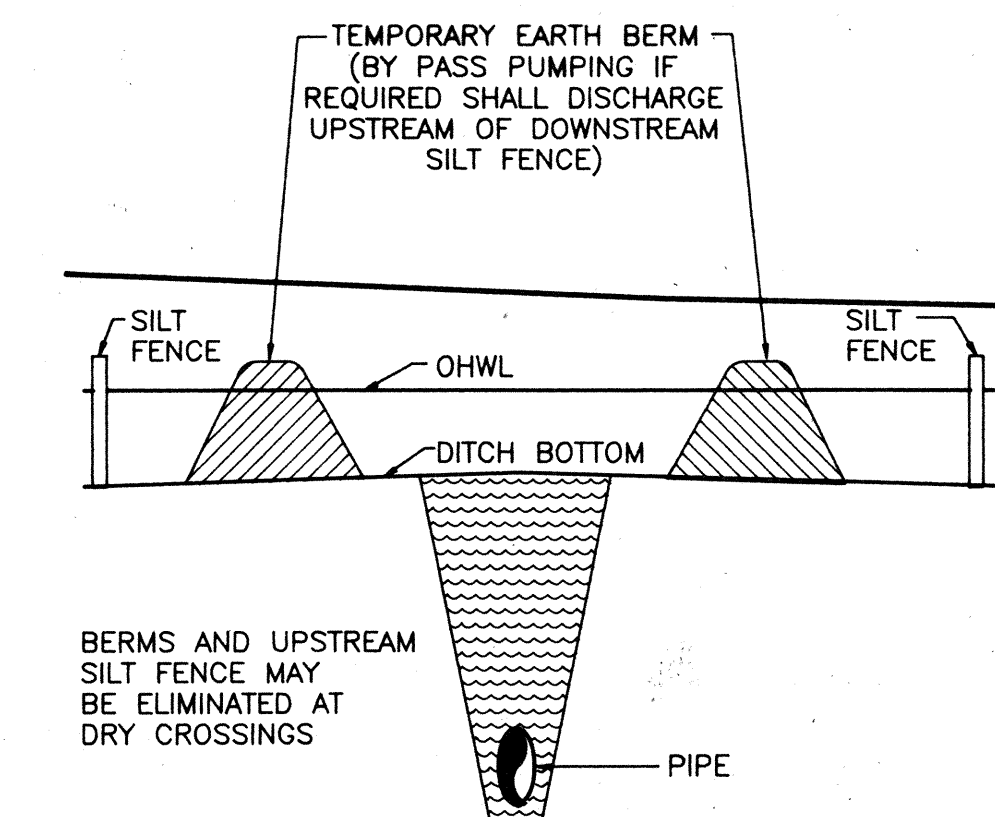

UNDERGROUND PIPE CROSSINGS
N.T.S.

FIGURE 12

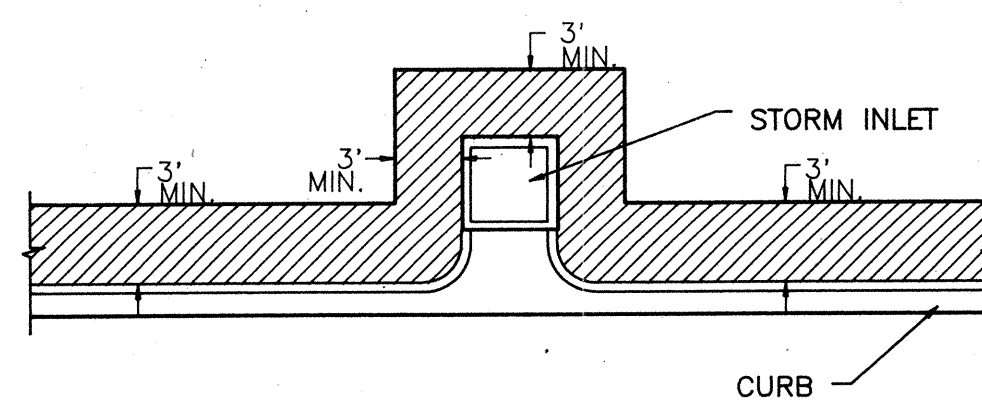

SOD ALONG CURB AND AROUND INLET
N.T.S.

FIGURE 13

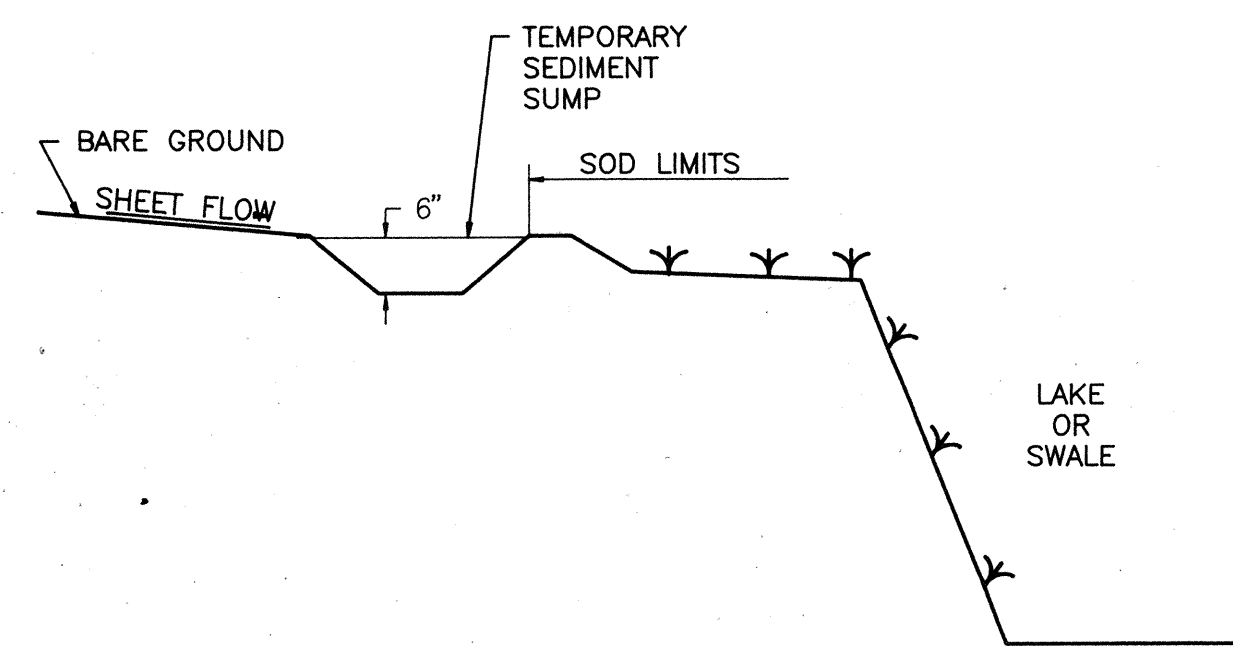

TEMPORARY SEDIMENT SUMP
N.T.S.

FIGURE 14

BEST MANAGEMENT PRACTICES

MINDER & RHODES ENGINEERING CORPORATION
 Engineers - Planners - Surveyors
 3900 CLARK ROAD
 SARASOTA, FL 34233
 (813) 422-7948
 Designed: WBH / Checked: N/A / Scale: N/A / Approved: Date: 07/30/92
 Drawn: DBH / CAD DWG: ST088BM

REVISIONS	No.	Date	Descriptions	By

**WESTON POINTE
 LONGBOAT KEY**
 SARASOTA COUNTY, FLORIDA
BEST MANAGEMENT PRACTICES